

Cast Deckmount Sink Faucets 4" Centers

TECK[®]
COMMERCIAL

DELTA[®]

Specification: (example)

- **HEAVY DUTY CAST BRASS** sink faucet
- 102mm (4") centers, two handle
- Polished chrome plated finish
- **BRASS** swing spout or 3/8" IPS **BRASS PIPE** Rigid/Swivel Gooseneck Spout
- Metal hold-down package
- Color indexed metal handles with vandal resistant screws
- **CER-TECK[®]** 1/4 turn ceramic structures)

and ... with ... (add spout required)
 with ... (add outlet required)
 with ... (add handle required)
 with ... (add suffix **-LS** if required – See Back Page)
 with ... (add suffix **-TI** if required – See Back Page)

27C4834



27C4233

Engineer/Architect Approval













Model Specified:

Approval:

Date:

DESCRIPTION	PRODUCT NO.
CAST Deckmount LESS Pop-up	27C4



SPOUT	OUTLET	HANDLE
0 <input type="checkbox"/>	0 <input type="checkbox"/>	0 <input type="checkbox"/>
1 <input type="checkbox"/>	1 <input type="checkbox"/>	1 <input type="checkbox"/>
2 203mm (8") Tubular (S5) Swing Spout (2) <input type="checkbox"/> 	2 Vandal Resistant 1.5 gpm (5.7 L/min.) Laminar w/Agion [®] Antimicrobial <input type="checkbox"/> 	2 102mm (4") Hooded Blade Handles (5) <input type="checkbox"/> 
3 152mm (6") Tubular (S3) Swing Spout (2) <input type="checkbox"/> 	3 Vandal Resistant 1.5 gpm (5.7 L/min.) Flow Control Aerator <input type="checkbox"/> 	3 76mm (3") Hooded Lever Handles (5) <input type="checkbox"/> 
4 <input type="checkbox"/>	4 Standard 1.5 gpm (5.7 L/min.) Flow Control Aerator <input type="checkbox"/> 	4 102mm (4") Blade Handles, Sanitary Hoods (5) <input type="checkbox"/> 
5 <input type="checkbox"/>	5 Vandal Resistant 0.5 gpm (1.9 L/min.) Flow Control Non-Aerating Spray Outlet <input type="checkbox"/> 	5 152mm (6") Wrist Handles, Sanitary Hoods <input type="checkbox"/> 
6 <input type="checkbox"/>	6 <input type="checkbox"/>	6 <input type="checkbox"/>
7 <input type="checkbox"/>	7 Smooth End, Laminar Flow Control in Base of Gooseneck Spout 1.0 gpm (3.8 L/min.) (3) <input type="checkbox"/> 	7 <input type="checkbox"/>
8 Heavy Duty 114mm (4 1/2") Bend Rigid/Swivel (R2) Gooseneck Spout (1) (4) <input type="checkbox"/> 	8 <input type="checkbox"/>	8 <input type="checkbox"/>
9 Heavy Duty 152mm (6") Bend Rigid/Swivel (R4) Gooseneck Spout (1) (4) <input type="checkbox"/> 	9 <input type="checkbox"/>	9 <input type="checkbox"/>

(1) Available **Optional Rigid/Swivel Spouts**. These spouts can ONLY be added to **SPOUT Option No. 9**.
 (2) Available **Optional Swing Spouts**. These spouts can ONLY be added to **SPOUT Option No. 2**.
 (3) This outlet can ONLY be added to **SPOUT Option No.'s 8 or 9**. (4) 120° Limited Swing Spout available. Add Suffix **-LS**. (5) H & C Temperature Indicator Available. Add Suffix **-TI**.

Note: Use this page front and back as a product submittal sheet. Flow Rates are at 60 PSI. Refer to www.specselect.com for individual models.

Delta reserves the right (1) to make changes in specifications and materials, and (2) to change or discontinue models, both without notice or obligation. Dimensions are for reference only. See current full-line price book or www.specselect.com for finish options and product availability.

Approvals:

- CSA certified
- Complies to ASME A112.18.1/CSA B125.1
- Handles No. 2, 3, 4, and 5
Indicates compliance to ICC/ANSI A117.1
- Outlet options 2, 3, 4 and 7 are EPA WaterSense listed
- Verified compliant with 0.25% weighted average Pb content regulations

(Contact Delta Representative for State and/or Local Approvals.)

HANDLE TEMPERATURE INDICATORS

- Add suffix **"-TI"** to Product Number for handle temperature indicators "H" (red), "C" (blue).
- Available on handle options 2, 3 or 4 only.

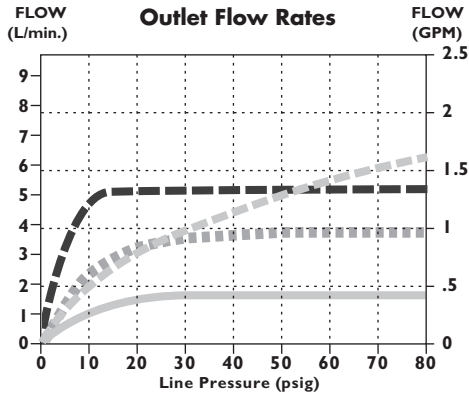

FLOW RATE vs PRESSURE

Spout Outlets

- No. 2 Laminar Flow Outlet
- No. 3 & 4 Aerator
- No. 5 Low Flow Outlet
- No. 7 Flow Control

DECK FAUCET

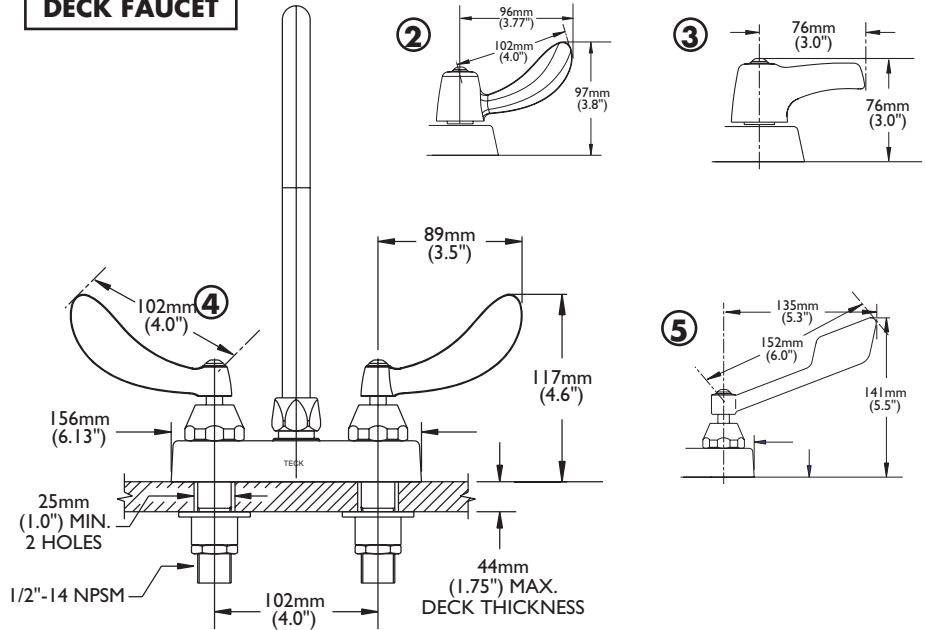

INLET FOR 3/8" OR 1/2" FLEXIBLE RISER
OR 1/2-14 NPSM COUPLING NUT (NOT SUPPLIED)

GOOSENECK SPOUTS

Outlets #2, 3, 4, 5

Outlet #7

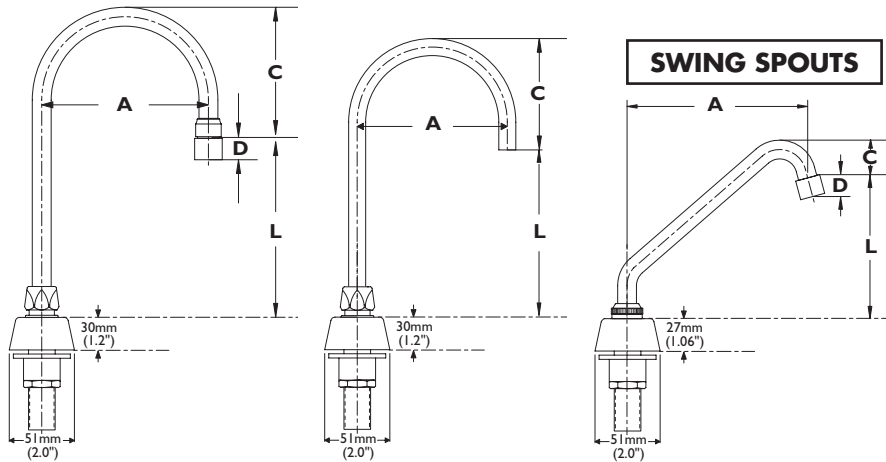

SWING SPOUTS

GOOSENECK SPOUT ASSEMBLY #8

SPOUT/OUTLET	"A"		"C"		"L"	
	mm	in.	mm	in.	mm	in.
Gooseneck-Standard (R2) for outlets #2, 3, 4, 5	114	4.5	104	4.1	170	6.7
Gooseneck-Standard (R2) for outlet #7	114	4.5	97	3.8	178	7.0

GOOSENECK SPOUT ASSEMBLY #9

SPOUT/OUTLET	"A"		"C"		"L"	
	mm	in.	mm	in.	mm	in.
Gooseneck-Standard (R4) for outlets #2, 3, 4, 5	152	6	124	4.9	146	5.8
Gooseneck-Standard (R4) for outlet #7	152	6	117	4.6	152	6.0

LIMITED SWING GOOSENECK

- Add suffix **"-LS"** to Product Number for 120° Limited Swing – Available on #8 or #9 spout with outlet #2, 3, 4, 5 ONLY.

SWING SPOUT ASSEMBLIES

SPOUT NO.	SPOUT TYPE	"A"		"C"		"L"	
		mm	in.	mm	in.	mm	in.
2	8" Tubular Spout (S5)	185	7.3	41	1.6	147	5.8
3	6" Tubular Spout (S3)	140	5.5	38	1.5	107	4.2

FOR OPTIONAL RIGID/SWIVEL & LIMITED SWING SPOUTS
See DSP-R/S for detailed specification

FOR OPTIONAL SWING SPOUTS
See DSP-S/S for detailed specification

OUTLET NO.	"D"	
	mm	in.
2	18	0.69
3	18	0.69
4	17	0.67
5	18	0.69

Note: Measurements may vary ± 6mm (0.25")