

Features

- Low-profile bolt caps create a sleek, minimalistic look and simplify cleaning.
- Conceals floor bolts on toilet.
- Unlike standard T-bolts, no bolt cutting is required.
- Caps firmly secure to washers and won't pop off.
- Clean Caps™ come standard with all KOHLER concealed toilets.
- This kit includes two bolt caps with bolts, depth gauges, T-nuts, and washers.













Codes/Standards

None Applicable

See website for detailed warranty information.

Available Color/Finishes

Color tiles intended for reference only.

Color	Code	Description
	0	White
	96	Biscuit
	47	Almond
	NY	Dune
	55	Innocent Blush™
	95	Ice™ Grey
	G9	Sandbar
	33	Mexican Sand™
	K4	Cashmere
	58	Thunder™ Grey
	7	Black Black™

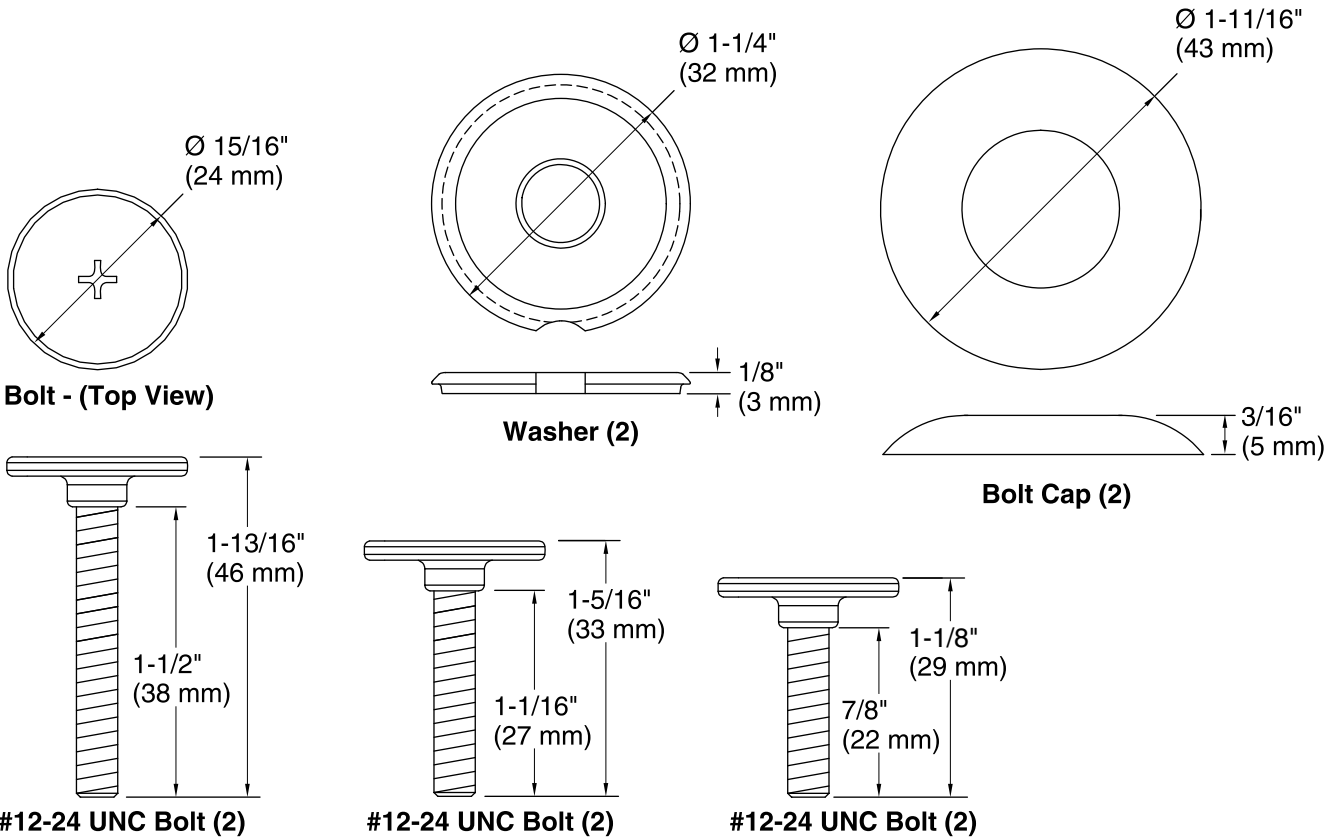

Technical Information

All product dimensions are nominal.

Notes

Install this product according to the installation guide.