



T855

Pro1 Technologies

P.O. Box 3377
 Springfield, MO 65808-3377
 Toll Free: 888-776-1427
 Web: www.pro1iaq.com
 Hours of Operation: M-F 9AM - 6PM Eastern

Thermostat Application Guide

Description	
Gas or Oil Heat	Yes
Electric Furnace	Yes
Heat Pump (No Aux. or Emergency Heat)	Yes
Heat Pump (With Aux. or Emergency Heat)	Yes
Multi-Stage Systems	Yes
Heat Only Systems	Yes
Cool Only Systems	Yes
Millivolt	Yes

Power Type

Battery Power
 Hardwire (Common Wire)
 Hardwire (Common Wire) with Battery Backup

A trained, experienced technician must install this product.

Carefully read these instructions. You could damage this product or cause a hazardous condition if you fail to follow these instructions.

Una version en espanol de este manual se puede descargar en la pagina web de la compania.

Table of Contents

Page

Installation Tips	2-4
Thermostat Quick Reference	5-8
Wiring	9-10
Wiring Diagrams	11-12
Technician Setup Menu	13-21
Programming	22-29
Features	30
Specifications	31

Wall Locations

The thermostat should be installed approximately 4 to 5 feet above the floor. Select an area with average temperature and good air circulation.

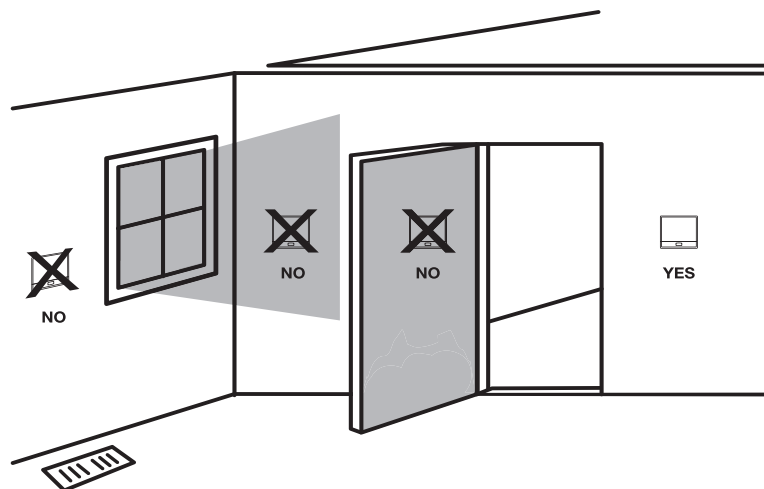

Do not install thermostat in these locations:

- Close to hot or cold air ducts
- That are in direct sunlight
- With an outside wall behind the thermostat
- In areas that do not require conditioning
- Where there are dead spots or drafts (in corners or behind doors)
- Where there might be concealed chimneys or pipes

Installation Tip

Pick an installation location that is easy for the user to access. The temperature of the location should be representative of the building.

1 © U.S. Registered Trademark. Patents pending
 Copyright © 2019 All Rights Reserved.

Rev. 1919

2

Installation Tips

Subbase Installation

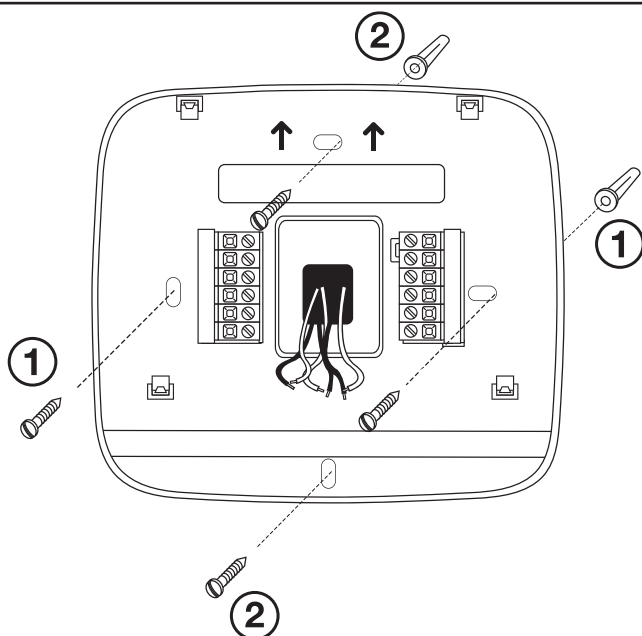

- Horizontal Mount** For horizontal mount put one screw on the left and one screw on the right.
- Vertical Mount** For vertical mount put one screw on the top and one screw on the bottom.

Installation Tip: Electrical Hazard

Failure to disconnect the power before beginning to install this product can cause electrical shock or equipment damage.

Mercury Notice

All of our products are mercury free. However, if the product you are replacing contains mercury, dispose of it properly. Your local waste management authority can give you instructions on recycling and proper disposal.

Installation Tips

Mount Thermostat

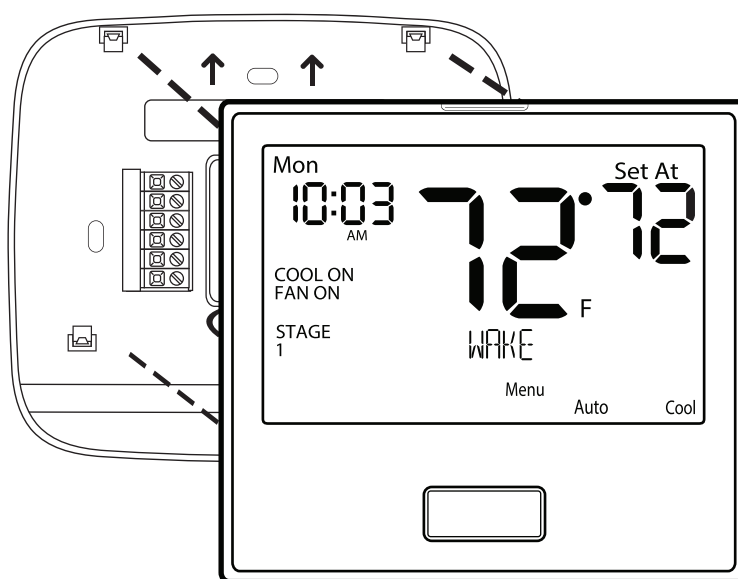

Align the 4 tabs on the subbase with corresponding slots on the back of the thermostat, then push gently until the thermostat snaps in place.

Note: To ensure a solid fit between the thermostat and the subbase:

1. Mount subbase to a flat wall
2. Use screws provided
3. Drywall anchors should be flush with the wall
4. Wires should be pushed into the wall

3

4

Battery Installation

Battery installation is recommended even if the thermostat is hardwired (C terminal connected). When the thermostat is hardwired and batteries are installed, the thermostat will activate a compressor delay of 5 minutes when it detects a power outage from the hardwired power supply.

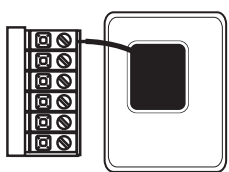

Important:

High quality alkaline batteries are recommended. Rechargeable batteries or low quality batteries do not guarantee a 1-year life span.

To release battery cover press finger bevel on the left side and lift the cover to access batteries.

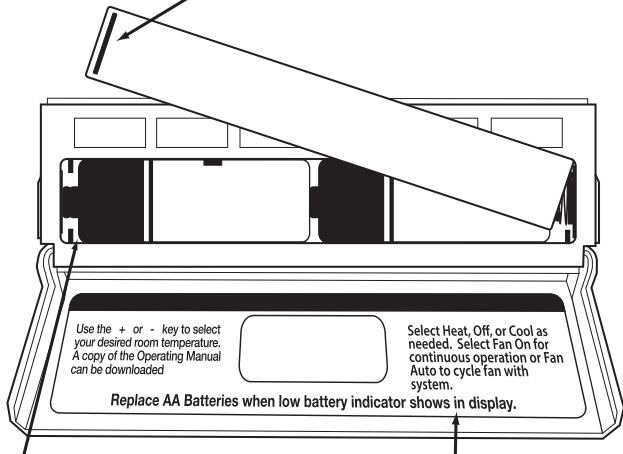

Insert 2 AA Alkaline batteries (included). High quality alkaline batteries are recommended.

Simple operating instructions are found on the back of the battery door.

Getting to know your thermostat

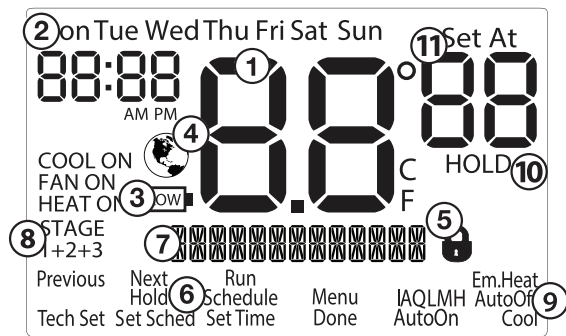

- ① **Displays the current room temperature**
- ② **Time and day of the week**
- ③ **Low Battery Indicator:** Replace batteries when this indicator is shown.
- ④ **Energy Efficient Globe:** Indicates efficient setpoint temperature.
- ⑤ **Keypad Lockout:** Indicates the thermostat is in keypad lockout.
- ⑥ **Program Menu Options:** Show different options during programming.
- ⑦ **Program Time Periods - Residential:** Uses 4 time periods - WAKE, RETURN, LEAVE & SLEEP. **Commercial:** Uses 2 or 4 time periods that appear in the text field - Occupied & Unoccupied.
- ⑧ **Staging Indicators:** 1 will appear in the display when first stage of heat or cool is on. +2 will appear for the second stage of heat. +3 will appear for the third stage of heat.
- ⑨ **System Operation Indicators:** If these or the Fan indicator are flashing, it means that the system is in a delay of some type (compressor delay, cooling fan delay, staging delay).
- ⑩ **Hold:** is displayed when the thermostat program is permanently overridden.
- ⑪ **Setpoint:** Displays the user selectable setpoint temperature.

Wiring

Caution: Electrical Hazard

Failure to disconnect the power before beginning to install this product can cause electrical shock or equipment damage.

Warning:

All components of the control system and the thermostat installation must conform to Class II circuits per the NEC Code.

Wiring

1. If you are replacing a thermostat, make note of the terminal connections on the thermostat that is being replaced. In some cases the wiring connections will not be color coded. For example, the green wire may not be connected to the **G** terminal.
2. Loosen the terminal block screws. Insert wires then retighten the terminal block screws.
3. Place nonflammable insulation into the wall opening to prevent drafts.

Installation Tip

Do not overtighten terminal block screws, as this can damage the terminal block. A damaged terminal block can keep the thermostat from fitting on the subbase correctly or cause system operation issues.

Max Torque = 6in-lbs.

Wiring Tips

C Terminal

The C (common wire) terminal does not have to be connected when the thermostat is powered by batteries.

Note:

In many heat pump systems with no emergency heat relay, a jumper can be installed between **E** and **W2** to turn thermostat into a single stage control for Emergency Heat Operation.

Wire Specifications

Use shielded or non-shielded 18-22 gauge thermostat wire.

Wiring

Terminal Designations

This thermostat is shipped from the factory to operate a conventional heating and cooling system. This thermostat may also be configured for a heat pump system. See the "heat pump" configuration step on page 14 of this manual to configure the thermostat for heat pump applications.

Terminal	2 Heat 2 Cool Conventional System	2 Heat 1 Cool Heat Pump System	3 Heat 2 Cool Heat Pump System
RC	Transformer power (cooling)	Transformer power (cooling)	Transformer power (cooling)
RH	Transformer power (heating)	Transformer power (heating)	Transformer power (heating)
C	Transformer common	Transformer common	Transformer common
B	Reversing valve / configerable terminal	Reversing valve / configerable terminal	Reversing valve / configerable terminal
O	Reversing valve / configerable terminal	Reversing valve / configerable terminal	Reversing valve / configerable terminal
G	Fan relay	Fan relay	Fan relay
W/E	First stage of heat	Emergency Heat	First stage of auxiliary heat
Y	First stage of cool	First stage of heat & cool	First stage of heat & cool
Y2	Second stage of cool	N/A	Second stage of heat & cool
W2	Second stage of heat	Auxiliary heat	Secodn stage of auxiliary heat

Getting to know your thermostat

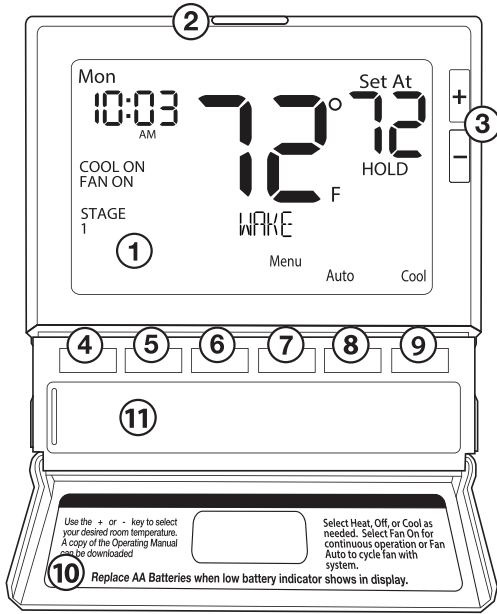

- 1 LCD Display
- 2 Glow in the dark light button
- 3 Setpoint buttons
- 4-6 Program buttons
- 7 Menu button
- 8 Fan button
- 9 System button
- 10 Button/battery access door
- 11 Battery cover

Important

The low battery icon is displayed when the AA battery power is low. Whenever the thermostat detects low battery voltage from the AA batteries, the low battery icon will begin flashing on the screen for 21 days (if the batteries are not changed). If the batteries are not changed 22 days after the thermostat detects low battery voltage, the thermostat screen will only show the flashing battery icon until buttons are pressed. If the batteries are not changed 43 days after the thermostat detects low battery voltage, the thermostat screen will only show the flashing battery icon until buttons are pressed and the set points will offset to 85°F/29°C in cooling and 55°F/13°C in heating. At this stage, set point changes can be made temporarily but, the set points will change back to defaulted values after a 4-hour period. The thermostat will continue to perform this low battery flashing, temperature offset condition until the internal voltage threshold is reached. When the thermostat internal voltage threshold is reached, all relays will be opened and the thermostat will become inoperable until new batteries are installed.

About The Badge

All of our thermostats use the same universal magnetic badge. Visit the company website to learn more about our free private label program.

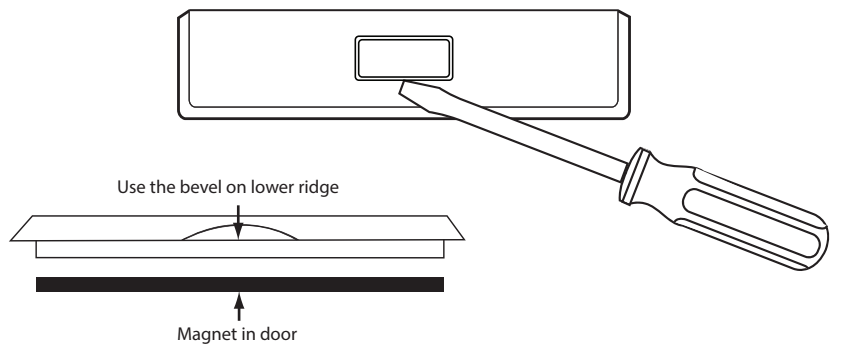

Gently slide a screwdriver into the bottom edge of the badge. Gently turn the screwdriver counter clockwise. The badge is held on by a magnet in the well of the battery door. The badge should pry off easily. **DO NOT USE FORCE.**

Wiring Diagrams

- 1 Power supply
- 2 Factory-installed jumper. Remove only when installing on 2-transformer systems

Typical 2H/2C System: 1 Transformer

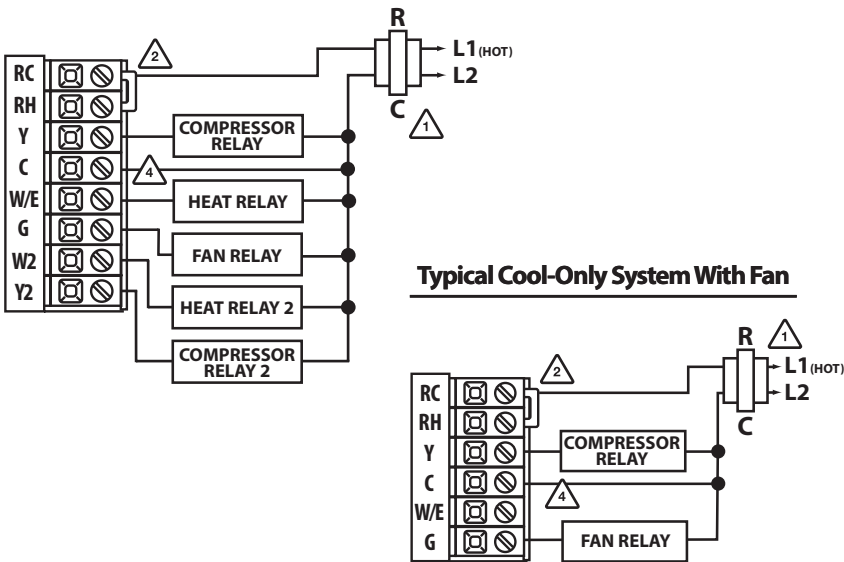

Wiring Diagrams

- 3 Use either O or B terminals for changeover valve
- 4 Optional 24 VAC common connection when thermostat is used in battery power mode

Typical 2H/2C System: 2 Transformer

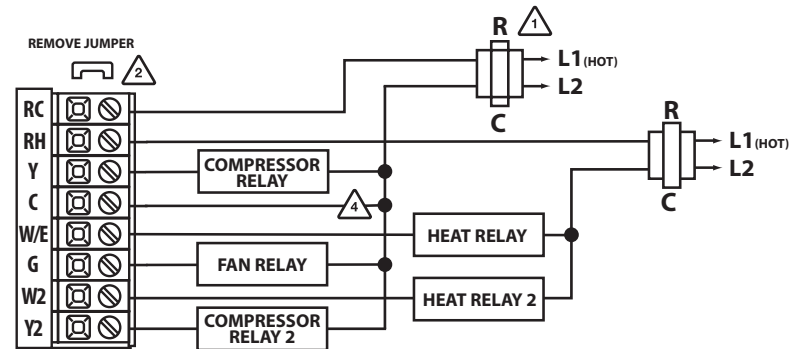

Typical Heat Only System With Fan

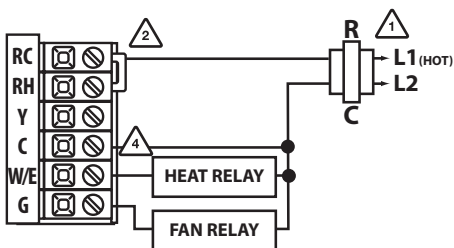

Note:

In many systems with no emergency heat relay a jumper can be installed between E and W2.

Typical 3H/2C or 2H/1C Heat Pump System

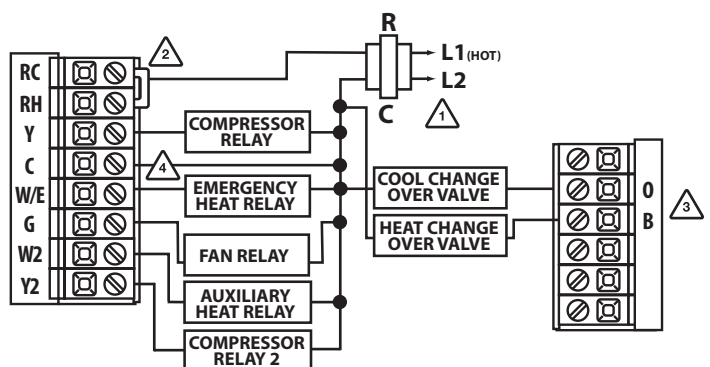

Technician Setup Menu

This thermostat has a technician setup menu for easy installer configuration. To set up the thermostat for your particular application:

1. Press the **MENU** button.
2. Press and hold the **TECH SET** button for 3 seconds. This 3 second delay is designed so that homeowners do not accidentally access the installer settings.
3. Configure the installer options as desired using the table below.

Use the **+** or **-** keys to change settings and the **NEXT** or **PREV** key to move from one step to another.

Note: Only press the **DONE** key when you want to exit the Technician Setup options.

4. Press the **DONE** key to exit.

Tech Setup Steps	LCD Will Show	Adjustment Options	Default
Filter Change Reminder	OF F ILTER	You can adjust the filter change reminder from "OFF" to 2000 hours of runtime in 50 hour increments.	OFF
Room Temperature Calibration	0 CAL IBRATE	You can adjust the room temperature display to read up to 4° above or below the factory calibrated reading.	0°F
Cooling Swing	0.5 COOL SW ING	The cooling swing setting is adjustable from 0.2° to 2°. For example: A swing setting of 0.5° will turn the cooling on at approximately 0.5° above the setpoint and turn the cooling off at approximately 0.5° below the setpoint.	0.5°

Swing Setting Tip

The second stage will turn on at 2x the swing setting. The second stage will turn off when 1x the swing is reached. For example, if the swing setting is .5 degrees for heating and the thermostat is set at 70°F, the first stage will turn on at approximately 69.5°F. The second stage will turn on at 69°F. The second stage will turn off at 69.5°F and the first will turn off at 70.5°F. If the third stage is used, it will turn on at 68.5°F and turn off at approximately 69°F.

13

14

Technician Setup Menu

Tech Setup Steps	LCD Will Show	Adjustment Options	Default
Heating Swing	0.4 HEAT SW ING	The swing setting often called "cycle rate", "differential", or "anticipation" is adjustable. A smaller swing setting will cause more frequent cycles and a larger swing setting will cause fewer cycles.	0.4°
PTAC Mode	OF PTAC MODE	This setting allows the thermostat to operate a PTAC. This will allow for multiple fan speeds selectable in the next two tech settings.	ON
PTAC Fan Speeds (Only displayed if PTAC mode is ON)	2 FAN SPEEDS	This setting allows you to choose the number of fan speeds the thermostat will control.	2 1. Speeds: ON, Auto 2. Speeds: Low, High, Auto 3. Speeds: Low, Med, High, Auto
PTAC Medium Fan Speed Terminal (Only displayed if PTAC mode is ON and PTAC fan speeds is set to 3)	0 MED FAN TERM	This setting will select the terminal for medium fan speed operations. The selected terminal cannot be used for reversing valve operations when heat pump is enabled.	0
Heat Pump	OF HEAT PUMP	When turned on the thermostat will operate a heat pump. EM. Heat will show as an option in the system switch tech setting. Use the + and - button to adjust.	OFF OFF configures the thermostat for conventional systems. ON configures the thermostat for heat pump systems.
Stages of Heat	2H HEAT STAGES	This setting allows you to select the number of heat stages.	2H Use the + and - buttons to select 1H, 2H, 3H, 4H.

Technician Setup Menu

Tech Setup Steps	LCD Will Show	Adjustment Options	Default
Fresh Air Terminal (Only displayed if fresh air mode is turned ON. This setting cannot be used with PTAC, three stages of cool, or economizer turned on)	0 FRESH AIR TERM	Use the + and - buttons to select O/B.	0
Fresh Air Minutes	40 FRESH AIR MIN	Use the + and - buttons to select 5, 10, 15, 20, 25, 30, 35, 40, 45, 50, 55 or 60 minutes.	5
Program Options	5d PROGRAM	Use the + and - button to select 7d for 7 day, 5d for 5+1+1, or 0d for non-programmable. Note: If 7d is selected, in set schedule you will program all seven days individually. If 5d is selected, in set schedule you will program Monday – Friday together and Saturday and Sunday individually. If 0d is selected the thermostat becomes non-programmable and the Set Schedule button goes away in Menu.	5d
Time Periods (Only displayed if program option is set to 5d or 7d)	4 TIME PER IODS	Use the + and - buttons to select 4, 2C, or 4C time periods per day. 4: Wake, Leave, Return & Sleep. 2C: time periods are Occupied & Unoccupied. 4C: time periods are Occupied 1, Unoccupied 1, Occupied 2, & Unoccupied 2	4

Technician Setup Menu

Tech Setup Steps	LCD Will Show	Adjustment Options	Default
Pro Recovery	ON PRO RECOVERY	This feature will start heating and cooling early to bring the building temperature to its programmed setpoint by the beginning of the WAKE, RETURN and OCCUPIED time periods.	ON Use the + or - key to select on or off.
Cycle Minimizer (Only displayed if program option is set to 5d or 7d)	OF CYCLE MIN	This setting maximizes efficiency and equipment longevity by increasing the heating and cooling swing settings to 2° during the unoccupied and leave time periods. This will result in significantly fewer system cycles.	OFF Use the + or - key to select on or off.
Keypad Lockout	OF KEY LOCKOUT	Keypad lockout allows you to configure the thermostat so some or all of the keys don't function.	OFF Use the + and - buttons to select OFF, BASIC, PART, FULL OF - OFF= keypad lockout has been disabled. BA - BASIC = basic keypad lockout locks the menu key. PA - PARTIAL= partial keypad lockout, which locks all the keys except the or setpoint keys. FU - FULL= full keypad lockout, which locks out all the keys.
Heat Setpoint Limit	HE HEAT LIMIT	This feature allows you to set a maximum heating setpoint limit. The setpoint temperature cannot be raised above this value.	90°F Use the + or - key to select the maximum heat setpoint and the minimum cooling setpoint.

Keypad Lockout Note: The selected keypad lockout functionality must be activated after exiting tech setup. If you do not perform this procedure, all keys will function freely. To lock the keypad hold down the **+** and **-** keys for 3 seconds. You will see a lock in the display. To unlock the display hold down the **+** and **-** keys for 3 seconds.

17

18

Technician Setup Menu

Tech Setup Steps	LCD Will Show	Adjustment Options	Default
Stages of Cool This setting allows you to select the number of cool stages.	2C COOL STAGES	Use the $\left[\right]$ and $\left[\right]$ buttons to select 1C, 2C.	2C
System Set You can configure the system switch for the particular application. Heat - Off - Cool, Heat - Off, Cool - Off, Heat - Off - Cool - Auto. Note: Emergency Heat is available in heat pump mode only.	SYSTEM SET AutoOff Em.Heat Cool	Use the $\left[\right]$ or $\left[\right]$ buttons until the desired application is flashing. AUTO = (Auto Changeover)	OFF
Dual Fuel Auxiliary For Heat Pump This setting allows the system to run Gas, Oil, Propane or any other types of auxiliary heat. The thermostat will default to electric auxiliary heat in heat pump applications.	OF DUAL FUEL	Use the $\left[\right]$ and $\left[\right]$ buttons to select ON/OFF.	OFF
Electric or Gas Fan Operation Select GAS to have the system control the fan during a call for heat, select Electric to have the thermostat control the fan during a call for heat. Note: If heat pump is set to "ON" this step will not show, and will default to ELECTRIC.	GAS FAN SET	Use $\left[\right]$ and $\left[\right]$ buttons to change the setting.	GAS
Satisfy Setpoint Staging (Only displayed if there are more than one stage of heat or cool) This feature allows the thermostat to keep multiple stages of heat or cool energized until the setpoint is satisfied.	OF SS STAGING	Use the $\left[\right]$ or $\left[\right]$ buttons to turn on/off.	OFF
Staging Delay (Only displayed if there are more than one stage of heat or cool) This feature allows a delay to occur if an additional stage is needed. This allows the previous stage extra time to satisfy the setpoint. Note: Will not show if using outdoor sensor with balance point temperature.	OF STAGING DELAY	Use the $\left[\right]$ or $\left[\right]$ key to select OFF, 5, 10, 15, 30, 45, 60, or 90 minutes.	OFF

15

Technician Setup Menu

Tech Setup Steps	LCD Will Show	Adjustment Options	Default
Minimum Compressor On Time This feature allows the installer to select the minimum run time for the compressor. For example, a setting of 4 will force the compressor to run for at least 4 minutes every time the compressor turns on, regardless of the room temperature.	OF MIN COMP ON	You can set the minimum compressor run time to "OFF", "3", "4", or "5" minutes. If 3, 4 or 5 is selected, the compressor will run for at least the selected time before turning off. Use the $\left[\right]$ and $\left[\right]$ buttons to change the setting.	OFF
Compressor Short Cycle Delay The compressor short cycle delay protects the compressor from "short cycling". This feature will not allow the compressor to be turned on for 5 minutes after it was last turned off.	ON COMP DELAY	Selecting "ON" will not allow the compressor to be turned on for 5 minutes after the last time the compressor was on. Select "OFF" to remove this delay. Use the $\left[\right]$ and $\left[\right]$ buttons to change the setting.	ON
Cooling Fan Delay The cooling fan delay setting will delay the fan from coming on in cool mode and keep it running after the compressor shuts off for a short time to save energy in some systems.	OF COOL FAN DL	You can set the cooling fan delay to OFF, 15, 30, 60 or 90 seconds. If 15, 30, 60, or 90 is selected the fan will not turn on for that many seconds when there is a call for cool and will run for that many seconds after satisfying a call for cool.	OFF
Fresh Air Mode (This setting cannot be used with PTAC, three stages of cool, or economizer turned on) This feature allows fresh air into a unit for a selectable time period. When Fresh Air Mode is enabled, the fan and the fresh air damper terminal will energize simultaneously.	OF FRESH AIR	Use the $\left[\right]$ and $\left[\right]$ buttons to select OFF, OC ON or ON. OFF: Thermostat does not enable Fresh Air Mode. OC ON: Fresh Air Mode is enabled during the OCCUPIED, WAKE, RETURN, and SLEEP time periods (It will not bring in fresh air during UNOCCUPIED and LEAVE time periods). ON: Thermostat will enable Fresh Air Mode for every time periods.	OFF

16

Technician Setup Menu

Tech Setup Steps	LCD Will Show	Adjustment Options	Default
Cool Setpoint Limit This feature allows you to set a minimum cooling setpoint limit. The setpoint temperature cannot be lowered below this value.	CO COOL LIMIT	Use the $\left[\right]$ or $\left[\right]$ key to select the minimum cooling setpoint.	44°F
°F or °C This feature allows you to display temperatures in either Fahrenheit or Celsius.	OF F OR C SET	°F for Fahrenheit °C for Celsius	°F
12 or 24 Hour Clock You can select either a 12 or 24 hour clock setting.	12 CLOCK SET	Use the $\left[\right]$ or $\left[\right]$ key to select 12 or 24 hour clock.	12H
Pre Occupancy Fan The pre-occupancy fan settings will energize the fan before the occupied time to provide ventilation prior to scheduled occupancy time periods. This feature only shows if the technician setup step for time periods is set to 2C or 4C. Use the $\left[\right]$ and $\left[\right]$ buttons to adjust.	OF PRE-OCC FAN	You can select the pre-occupancy fan from OFF, 1, 2, or 3 hours. If 1, 2, or 3 is selected, the fan will turn on that many hours prior to the scheduled occupied time period.	OFF
Display Light The display light can be configured to stay on all the time or turn on when any key is pressed. There are LOW and HIGH selections for continuous ON selection. NOTE: The thermostat will need to be hardwired in order for the LOW and HIGH display light functions to work properly. "ALWAYS ON LIT" will alternate in the text field with "HARDWIRE ONLY" when HIGH is selected. These prompts will alternate every three seconds. If the thermostat is hardwired this feature will default to LOW.	dl ALWAYS ON LIT dl HARDWIRE ONLY	Use the $\left[\right]$ and $\left[\right]$ buttons to select OFF, LOW, or HIGH. OFF configures the display light to come on when the light key or any button is pressed. LOW configures the display light to stay on at a low intensity constantly. When a button is pressed, the display light will transition to high intensity. HIGH configures the display light to remain on at high intensity all the time.	OFF If Battery Powered LOW If Hardwired

19











Technician Setup Menu

Tech Setup Steps	LCD Will Show	Adjustment Options	Default
Contractor Call Number This feature allows you to put your phone number in the display. You can choose ON or OFF. Notes: If contractor call number is selected ON, the phone number entered will show in the display if there has been a continuous call for heating or cooling for 24 hours or if the light button is held down for 3 seconds. To remove the phone number from the display, hold the light button down for 3 seconds.	OF PHONE NUMBER	If selected ON, you will see the input screen after pressing NEXT STEP. Use the $\left[\right]$ or $\left[\right]$ button to select the desired number and the FAN or SYSTEM key to move from one character to another. See note below for operation.	OFF
IAQ Mode Cycle This feature will configure the fan to run a selected number of cycles per hour. Note: This mode can be enabled or disabled at anytime during normal operation by selecting IAQ mode with the fan key. Turning this feature on shows IAQ option in fan key. Notes: This programmable/selectable mode will operate the fan 1-4 cycles per hour, 1-45 minutes per cycle. Once programmed in tech setup, to enable this mode select "IAQ" with the fan key. Disable this mode by selecting "ON" or "AUTO" with the fan key.	OF AQ MODE CYCL	Select OFF, 1, 2, 3 or 4 with the $\left[\right]$ or $\left[\right]$ buttons. This sets the number of cycles per hour that the IAQ fan mode will operate.	OFF

Contractor Call Number Note

If contractor call number is selected ON, the phone number entered will show in the display if there has been a continuous call for heating or cooling for 24 hours or if the light button is held down for 3 seconds. To remove the phone number from the display, hold the light button down for 3 seconds.

20







Tech Setup Steps	LCD Will Show	Adjustment Options	Default
<p>IAQ Minutes Per Cycle</p> <p>This allows you to select the minimum number of minutes that the fan will run per IAQ mode cycle. The thermostat will keep track of fan runtime from normal heat and cool operation. If additional fan runtime is needed, the thermostat will run the fan to satisfy the IAQ mode minutes. Notes: This programmable/selectable mode will operate the fan 1-4 cycles per hour, 1-45 minutes per cycle. Once programmed in tech setup, to enable this mode select "IAQ" with the fan key. Disable this mode by selecting "ON" or "AUTO" with the fan key.</p>		<p>Select 1, 5, 10, 15, 20, 30 or 45 minutes. When IAQ fan mode is enabled, it will ensure the fan runs at least the selected number of minutes per IAQ Mode Cycle. This step will not appear if previous step is set to "OFF".</p>	1
<p>Humidity Pad Reminder</p> <p>Enables a reminder for the user to change the humidity pad.</p>		<p>Use the  or  key to select OFF, 600, 1000, 1500, or 2000. These represent hours of heat operation.</p>	OFF
<p>UV Lamp Reminder</p> <p>Enables a reminder for the user to change the UV light bulb.</p>		<p>Use the  or  key to select OFF, 1 YR, 2 YR</p>	OFF
<p>IAQ Cell Reminder</p> <p>Enables a reminder for the user to change the IAQ Cell after 25,000 hrs.</p>		<p>Use the  or  buttons to select OFF, or 25 (stands for 25,000 hours).</p>	OFF

A Note about IAQ Mode

This programmable/selectable mode will operate the fan 1-4 cycles per hour, 1-45 minutes per cycle. Once programmed in tech setup, to enable this mode select "IAQ" with the fan key. Disable this mode by selecting "ON" or "AUTO" with the fan key.

Set Time

Follow the steps below to set the day of the week and current time:

1. Press the **MENU** button.
2. Press **SET TIME**.
3. Day of the week is flashing. Use the  or  key to select the current day of the week.
4. Press **NEXT**.
5. The current hour is flashing. Use the  or  key to select the current hour. When using 12-hour time, make sure the correct a.m. or p.m. choice is selected.
6. Press **NEXT**.
7. Minutes are now flashing. Use the  or  key to select current minutes.
8. Press **DONE** when completed.

Programming

All our programmable thermostats are shipped with an energy saving default program. You can customize this default program by following the instructions in the **set program schedule section** starting on page 24.

Your thermostat can be programmed to have each day of the week programmed uniquely (7 days), all the weekdays the same with a separate program for Saturday and a separate program for Sunday (5+1+1), or non-programmable. For the 7-day and 5+1+1 programming modes, there are three time period options.

1. "4" Residential (**WAKE, LEAVE, RETURN, SLEEP**)
2. "2C" Commercial (**OCCUPIED, UNOCCUPIED**)
3. "4C" Commercial (**OCCUPIED 1, UNOCCUPIED 1, OCCUPIED 2, UNOCCUPIED 2**)

This thermostat has a programmable fan feature, which allows you to run the fan continually during any time period.





Reminders

Once a reminder has been turned on and set, the elapsed time can be checked by navigating to its tech setup step. The elapsed time will then appear in the text field. It can also be reset at that time by holding down the set time/run sched button for 3 seconds. Resetting an expired reminder can be done without entering tech setup, by holding down the set time/run sched button for 3 seconds from the home screen.

Programming

To customize your 7 day 4 time period Program schedule, follow these steps:

Monday:

1. Select **HEAT** or **COOL** with the **SYSTEM** key.
Note: You have to program heat and cool each separately.
2. Press the **MENU** button (If menu does not appear first, press **RUN SCHED**).
3. Press **SET SCHED**. **Note:** Monday is displayed and the **WAKE/OCC1** icon is shown. You are now programming the **WAKE/OCC1** time period for that day.
4. Time is flashing. Use the  or  key to make your time selection for that day's **WAKE/OCC1** time period.
Note: If you want the fan to run continuously during this time period, select **ON** with the **FAN** key. If you want to use **IAQ** mode during this time period, select **IAQ** with the **FAN** key.
5. Press **NEXT**.
6. The setpoint temperature is flashing. Use the  or  key to make your setpoint selection for that day's **WAKE/OCC1** period.
7. Press **NEXT**.
8. Repeat steps 4 through 7 for that day's **LEAVE/UNOCC1** time period, for that day's **RETURN/OCC2** time period, and for that day's **SLEEP/UNOCC2** time period.

Repeat steps 4 through 8 for the remaining days of the week.

A Note About Auto Changeover:





In Auto you have the ability to switch between Auto Heat or Auto Cool by pressing the system key. This can be done once the current mode has reached its setpoint. For example: if in Auto Heat, the heat setpoint must be satisfied before the thermostat will allow you to switch to Auto Cool. You can switch out of Auto by holding down the system key. To get back into Auto, you must toggle the system key to Auto.

Programming

Set Program Schedule For Two Time Periods (OCCUPIED, UNOCCUPIED)

To customize your 5+1+1 Program schedule, follow these steps:

Weekday:

1. Select **HEAT** or **COOL** with the **SYSTEM** key.
Note: You have to program heat and cool each separately.
2. Press the **MENU** button (If menu does not appear first, press **RUN SCHED**).
3. Press **SET SCHED**. **Note:** Monday-Friday is displayed and the **OCCUPIED** text is shown. You are now programming the **OCCUPIED** time period for that day.
4. Time is flashing. Use the  or  key to make your time selection for the weekday **OCCUPIED** time period.
Note: If you want the fan to run continuously during this time period, select **ON** with the **FAN** key. If you want to use **IAQ** mode during this time period, select **IAQ** with the fan key.
5. Press **NEXT**.
6. The setpoint temperature is flashing. Use the  or  key to make your setpoint selection for the weekday **OCCUPIED** period.
7. Press **NEXT**.
8. Repeat steps 4 through 7 for the weekday **UNOCCUPIED** time period.

Saturday:

Repeat steps 4 through 7 for the Saturday **OCCUPIED** time period and for the Saturday **UNOCCUPIED** time period.

Sunday:

Repeat steps 4 through 7 for the Sunday **OCCUPIED** time period, and for the Sunday **UNOCCUPIED** time period.

Set Program Schedule For Four Time Periods

(WAKE, LEAVE, RETURN, SLEEP or OCCUPIED 1, UNOCCUPIED1, OCCUPIED 2, UNOCCUPIED 2)

To customize your 5+1+1 Program schedule, follow these steps:

Weekday:

1. Select **HEAT** or **COOL** with the system switch.
Note: You have to program heat and cool each separately.
2. Press the **MENU** button (If menu does not appear first press **RUN SCHED**).
3. Press **SET SCHED**. **Note:** Monday-Friday is displayed and the **WAKE/OCC1** icon is shown. You are now programming the **WAKE/OCC1** time period for the weekday setting.
4. Time is flashing. Use the **+** or **-** key to make your time selection for the weekday **WAKE/OCC1** time period.
Note: If you want the fan to run continuously during this time period, select **ON** with the **FAN** key. If you want to use **IAQ** mode during this time period, select **IAQ** with the **FAN** key.
5. Press **NEXT**.
6. The setpoint temperature is flashing. Use the **+** or **-** key to make your setpoint selection for the weekday **WAKE/OCC1** period.
7. Press **NEXT**.
8. Repeat steps 4 through 7 for the weekday **LEAVE/UNOCC1** time period, for the weekday **RETURN/OCC2** time period, and for the weekday **SLEEP/UNOCC2** time period.

Saturday:

Repeat steps 4 through 7 for the Saturday **WAKE/OCC1** time period, for the Saturday **LEAVE/UNOCC1** time period, for the Saturday **RETURN/OCC2** time period, and for the Saturday **SLEEP/UNOCC2** time period.

Sunday:

Repeat steps 4 through 7 for the Sunday **WAKE/OCC1** time period, for the Sunday **LEAVE/UNOCC1** time period, for the Sunday **RETURN/OCC2** time period, and for the Sunday **SLEEP/UNOCC2** time period.

Custom Program

Day of the Week	Events	Time	Setpoint Temperature (HEAT)	Setpoint Temperature (COOL)
Weekday	Wake/OCC1			
	Leave/UNOCC1			
	Return/OCC2			
	Sleep/UNOCC2			
	Occupied			
	Unoccupied			
Saturday	Wake/OCC1			
	Leave/UNOCC1			
	Return/OCC2			
	Sleep/UNOCC2			
	Occupied			
	Unoccupied			
Sunday	Wake/OCC1			
	Leave/UNOCC1			
	Return/OCC2			
	Sleep/UNOCC2			
	Occupied			
	Unoccupied			

To customize your 7 day 2 time period program schedule, follow these steps:

Monday:

1. Select **HEAT** or **COOL** with the **SYSTEM** key.
Note: You have to program heat and cool each separately.
2. Press the **MENU** button (If menu does not appear first press **RUN SCHED**).
3. Press **SET SCHED**. **Note:** Monday is displayed and the **OCCUPIED** text is shown. You are now programming the **OCCUPIED** time period for that day.
4. Time is flashing. Use the **+** or **-** key to make your time selection for that day's **OCCUPIED** time period.
Note: If you want the fan to run continuously during this time period, select **ON** with the **FAN** key. If you want to use **IAQ** mode during this time period, select **IAQ** with the fan key.
5. Press **NEXT**.
6. The setpoint temperature is flashing. Use the **+** or **-** key to make your setpoint selection for that day's **OCCUPIED** period.
7. Press **NEXT**.
8. Repeat steps 4 through 7 for that day's **UNOCCUPIED** time period.

Repeat steps 4 through 8 for the remaining days of the week.

A Note About Programmable Fan:

The programmable fan feature will run the fan continuously during any time period it is programmed to be on. This is the best way to keep the air circulated and to eliminate hot and cold spots in your building. If using **IAQ** mode, set fan to **IAQ** for any time period.

Default Programming

Factory Default Program

Day of the Week	Events	Time	Setpoint Temperature (HEAT)	Setpoint Temperature (COOL)
Weekday	Wake/OCC1	6 AM	70°F (21°C)	75°F (24°C)
	Leave/UNOCC1	8 AM	62°F (17°C)	83°F (28°C)
	Return/OCC2	6 PM	70°F (21°C)	75°F (24°C)
	Sleep/UNOCC2	10 PM	62°F (17°C)	78°F (26°C)
Saturday	Wake/OCC1	6 AM	70°F (21°C)	75°F (24°C)
	Leave/UNOCC1	8 AM	62°F (17°C)	83°F (28°C)
	Return/OCC2	6 PM	70°F (21°C)	75°F (24°C)
	Sleep/UNOCC2	10 PM	62°F (17°C)	78°F (26°C)
Sunday	Wake/OCC1	6 AM	70°F (21°C)	75°F (24°C)
	Leave/UNOCC1	8 AM	62°F (17°C)	83°F (28°C)
	Return/OCC2	6 PM	70°F (21°C)	75°F (24°C)
	Sleep/UNOCC2	10 PM	62°F (17°C)	78°F (26°C)

Default Programming

Factory Default Program for 2 Time Periods				
Day of the Week	Events	Time	Setpoint Temperature (HEAT)	Setpoint Temperature (COOL)
Weekday	OCCUPIED	8 AM	70° F (21° C)	78° F (26° C)
	UNOCCUPIED	6 PM	62° F (17° C)	83° F (28° C)
Saturday	OCCUPIED	8 AM	70° F (21° C)	78° F (26° C)
	UNOCCUPIED	6 PM	62° F (17° C)	83° F (28° C)
Sunday	OCCUPIED	8 AM	70° F (21° C)	78° F (26° C)
	UNOCCUPIED	6 PM	62° F (17° C)	83° F (28° C)

You can use the table on the next page to plan your customized program schedule if using 5+1+1.

Filter Change & Other Reminders

If the filter change reminder is enabled, you will see a reminder in the display when your air filter needs changed. The reminder will be shown in the display after your system has run long enough to require an air filter change.

Resetting The Filter Change Reminder: When the reminder is displayed, you should change your air filter and reset the reminder by holding down the 3rd button from the left side of the thermostat for 3 seconds.

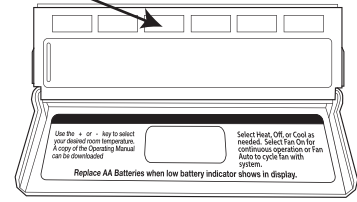

This thermostat also has other maintenance reminders (Humidity Pad, UV lamp, and IAQ Cell), that are reset with the same procedure.

Temporary & Permanent Hold Feature

Temporary Hold: The thermostat will display **HOLD** and **RUN SCHED** on the bottom of the screen when you press the **+** or **-** key. If you do nothing, the temperature will remain at this setpoint temporarily for 4 hours. The program setpoint will then replace the temporary setpoint.

Permanent Hold: With a temporary hold set, If you press the **HOLD** key at the bottom of your screen, you will see **HOLD** appear below the setpoint temperature in the display. The thermostat will now permanently stay at this setpoint and can be adjusted using the **+** or **-** keys.

To Return To Program: Press the **RUN SCHED** key at the bottom of the screen to exit temporary and permanent holds.

Specifications

Specifications

The display range of temperature ...	41°F to 95°F (5°C to 35°C)
The control range of temperature....	44°F to 90°F (7°C to 32°C)
Load Rating.....	1 amp per terminal, 1.5 amp maximum all terminals combined
Swing (cycle rate or differential)	Heating is adjustable from 0.2° to 2.0° Cooling is adjustable from 0.2° to 2.0°
Power source	18 to 30 VAC, NEC Class II, 50/60 Hz for hardwire Battery power from 2 AA Alkaline batteries
Operating ambient	32°F to +105°F (0°C to +41°C)
Operating humidity	90% non-condensing maximum
Dimensions of thermostat	4.7" W x 4.3" H x 0.9" D