

Features

- Pairs with KOHLER Verticyl rectangular under-mount bathroom sinks.
- Pilot holes for single, 4-inch centerset, and 8-inch wideset faucets.
- Sculpted edge.
- Coordinates with the industry-standard 36-inch vanities in the KOHLER® Tailored vanity collection.
- Field trimmable for alcove and corner installations.
- Optional side and backsplashes available (sold separately).

Material

- Solid surface.

Installation

- Vanity top.
- Includes mounting hardware for sink.
- Accommodates single, 4-inch, and 8-inch center faucet configurations.

Required Accessories

K-2882 Under-mount Bathroom Sink

Components

Additional included component/s: Mounting Screws.



Codes/Standards





None Applicable

KOHLER® One-Year Limited Warranty

See website for detailed warranty information.

Available Color/Finishes

Color tiles intended for reference only.

Color	Code	Description
	S33	White Expressions
	S34	Almond Expressions
	S35	Biscuit Expressions
	S36	Ice Grey Expressions

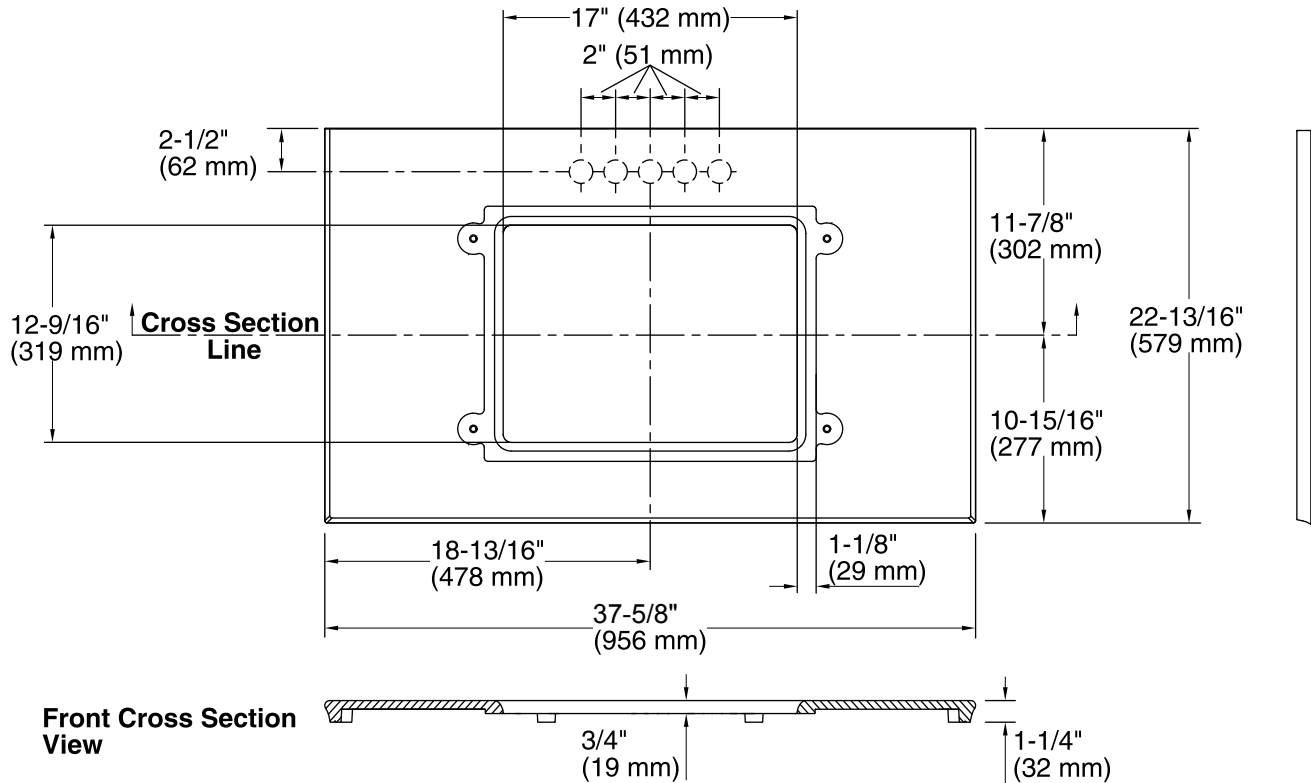

Technical Information

All product dimensions are nominal.

Bowl configuration: Single

Installation: ITB

Bowl area (Only): Length: 17" (432 mm)
Width: 12-9/16" (319 mm)

Notes

Install this product according to the installation instructions.

Observe all local plumbing and building codes. This countertop is designed to be installed with a KOHLER or standard-size vanity.

Faucet hole and sink-mounting locations are marked on the underside of the countertop.